



BOOST COOLER™

Congratulations on your purchase of a Snow Performance Boost Cooler® Gas Water-Methanol Injection kit! **Keep these instructions for reference.** First locate the part# of your injection system which can be found on the front of the Boost Cooler® box. Use this number to identify which set of electrical and setting instructions to follow.



CAUTION: You must completely read through these instructions before installing and operating this product. Failure to do so can result in damage to this product and the vehicle.

Required Tools Needed For Install:

- Phillips/Flat Head Screwdriver
- Power Drill
- Razor Blade
- Preferred Electrical Connectors (Crimping/Stripping Tools, Blue Butts, Eye Hooks, Posi-Taps, Fuse Taps, Soldering Supplies etc)
- Spare 16 Gauge Wire (Optional Depending On Install)
- Open End Wrench / Socket Set
- 1/8" – 27 NPT Tap (Optional Depending On Install)

Average Install Time: 4-6 Hours

www.snowperformance.net

© 2017 Snow Performance, Inc.



TECH TIP

Locate the wiring diagram for your injection kit further in these instructions beginning on page 8 for overview of system layout before attempting install.

Step 1 Self Sealing Low Level Sensor Install (Optional)

Although not required for kit operation, the low level sensor and yellow led are a great way to monitor the level of your water-meth tank. The level sensor is designed to turn on the led or alert the controller in some kits as soon as the level inside the reservoir reaches the level of the sensor.

Step 1: Remove plastic nut, plastic ring, and clear rubber gasket from level sensor assembly.

Step 2: Using either a 7/8" drill bit or a stepped drill bit. Drill the hole for the level sensor at the location in the tank you want to be alerted. Typical placement is 1/3rd of the tank height.



Step 3: Remove the cap from the tank and feed/pull wires through hole until level sensor is seated against plastic stopper.

Step 4: Reinstall the clear rubber gasket, plastic ring, and plastic nut onto the level sensor.

Step 5: Push clear rubber in until flush with outside of reservoir.

Step 6: Align the switch so the arrow is facing down. If arrow faces another direction the sensor will not operate.

Step 7: Tighten the plastic lock nut until the rubber gasket pushes firmly on the wall of the reservoir creating a leak free seal.



Step 2 Tank Install

OPTIONAL: If desired you can use the stock windshield washer fluid tank as the tank for your water-meth system. Simply drill and tap a 3/8" NPT hole in desired feed spot for system and install the 3/8" NPT fitting into the tank using E-6000 sealant on threads/around area.

If you do not want to use the OEM windshield washer fluid tank or 3qt tank, upgrades exist to move your tank to the trunk (See Part# SNO-40012 or SNO-40012-BRD) and other larger trunk mount tank options (See Part# SNO-40014 or SNO-40014-BRD)

Braided Line Kits Only:

Step 1: Install 3/8" NPT to 1/4" Quick Connect fitting or 3/8" NPT to 4AN Elbow fitting into the bottom of the reservoir using E6000® sealant on the threads.

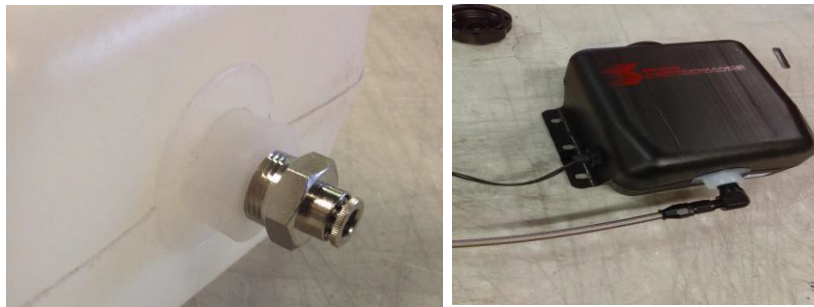

Step 2: After allowing the thread sealant to dry, fill reservoir with water and check for leaks around tank fitting and level sensor. If leak occurs use E6000® sealant.

Step 3: Install the 3qt. tank with four (4) #8x1&1/2" self-tapping screws and four (4) #8 washers (supplied) in desired mounting location. Typical placement is any void area inside the engine bay.



The reservoir should be installed above the pump, but below the nozzle. This keeps the pump primed and avoids fluid leaking into nozzle when not in use



CAUTION: To avoid gravity feeding of fluid with rear mount reservoirs or injection points past the throttle body it is essential to use a solenoid upgrade (Part # SNO-40060 / SNO-40060-BRD). Do not operate your rear mount reservoir equipped vehicle without an anti-siphon solenoid installed.

Step 3 Pump Install

Braided Line Kits Only- Install (2) 3/8" NPT to 4AN Straight fittings into the pump inlet and outlet using E6000® sealant on the threads. **Do not overtighten as damage to the pump housing can occur.**

Quick Connect Kits Only-(These Systems may include integrates push-lock fittings or 3/8" NPT adapter fittings for poly line.)

For integrated push-lock style pumps- Remove the blue rubber plugs from the quick-connect fittings by first pushing the plug toward the pump, hold the grey collar against the pump, and gently pull the blue plug from the fitting. Warning: Pulling against the quick connects with excessive force may cause fitting damage.

For 3/8 NPT threaded style pumps-Install the included 3/8 NPT-1/4" compression fittings into the pump inlet and outlet using E6000 sealant **(on the NPT side of the fitting only!)**

Do not overtighten, as damage to the pump housing will occur.



Step 1: Position the fluid pump so that the inlet is positioned at or below the lowest point of the reservoir, and within two feet of the reservoir. (Pump can be installed in any orientation). This will ensure the pump is primed with fluid for optimal flow and pressure to the nozzles.

Arrows on the pump inlet and outlet indicate the direction of fluid flow

Step 2: Install the fluid pump with four (4) #8x1&1/2" screws and four (4) #8 washers (supplied) in desired mounting location.

Step 3: Fit the high temp nylon tubing or braided line between the tank outlet fitting and the pump inlet, ensuring there are no kinks in the line and there is no stress on the fittings. Sharp kinks/bends can cause a leak in the system.

Braided Line Kits Only- Using the 2' or 1' stainless braided line section supplied in the kit connect the tank outlet to pump inlet.

Step 4 Nozzle Selection

Locate your Hyper-Sonic® water-methanol nozzles in the kit and compare the number stamped on the side to the above chart to determine its size. Nozzle sizing is determined by horsepower (which approximates the engine airflow) and boost (which approximates intake charge heat).

Determine your vehicle HP and boost/or no boost (N/A) and determine what size nozzle is needed for your application using the nozzle selection chart below. If you are unsure what nozzle to run with your given HP and boost send a email to tech@snowperformance.net for assistance.

Nozzle Selection Guide available at the link below:

https://www.nitrousexpress.com/images/nozzle_selection_guide.jpg

Seal the appropriate nozzle into the nozzle holder fitting using E6000® sealant on the nozzle threads.

****The end of the nozzle with the fine mesh screen should be inserted into the nozzle holder****



Correct



Correct

****Teflon sealants are not compatible with methanol, and should not be used with the install of your Snow Performance Boost Cooler®****

Step 5 Nozzle Mounting

Typical nozzle placement is approximately 6" or so before the throttle body inlet on the vehicle but the nozzle can be installed anywhere on the intake pipe after an intercooler outlet/supercharger outlet/turbo outlet. The nozzles should always be placed after an intercooler due to the possibility of the narrow passages and loss of air velocity leading to puddling. Nozzles should also be mounted after a MAF sensor due to the possibility of faulty readings. Nozzles should be mounted before a positive displacement supercharger.

Mounting for metal and rigid plastic: Drill and tap the intake tube with a 11/32" drill bit and a 1/8"-27 NPT thread tap in desired nozzle mounting location. ***To prevent debris from entering the engine, remove the intake tube from the vehicle prior to drilling***

Mounting in rubber boot (Nozzle Mount Adapter Part# SNO-40110): This sandwich adapter allows a secure threaded connection in any rubber intake boot for water-methanol nozzles.

Install the nozzle at a 90° angle to the direction of airflow, and so that the nozzle tip is flush with the inside of the intake tube or protruding slightly to ensure an uninterrupted spray pattern. Ensure the nozzles cone of spray has no obstructions near the mounting location.

- Install the nozzle assembly into the threaded intake tube using E-6000 sealant on the nozzle threads.
- Using a open end wrench, tighten the nozzle assembly ½ turn past finger tight so that the nozzle head is flush with the inside of the intake tube.
- Re-install the vehicle's intake tube into its proper mounting location.

Step 6 High Flow Check Valve Install

The check valve assembly (7 PSI Crack Pressure) will ensure that boost pressure does not back-feed air into the system or siphon due to engine vacuum. Ensure the check valve is installed with the arrow pointing in the direction of flow. The Check valve may be installed anywhere between the pump and nozzles. In a dual nozzle application the check valve will be placed between the pump and T fitting.

Quick Connect Kits Only- Fit the NPT thread to push connect adapters in both sides of the check valve using E-6000 sealant on the threads. Press the high pressure tubing in each fitting, ensuring the check valve is oriented properly in the direction of flow.



Braided line kits - Fit the NPT thread to 4AN adapters in each side of the check valve using E-6000 sealant on the NPT threads **only**. Connect the 5 foot section of braided line from the pump outlet to check valve inlet and the 1' or 2' section of braided line from the check valve outlet to the nozzle holder inlet.



When running the high pressure tubing or braided line from the in line check valve to the nozzle holder location, care should be taken to avoid extreme heat such as exhaust manifolds as well as any area that may abrade the line due to engine vibration and torque over. Also, ensure the lines are clear of the serpentine belt system.

Step 6 Unit Wiring (Wiring Diagram on page 8)

Connect the Red and Black pump wires to the corresponding Red and Black wires on the controller's MAIN Pump output harness.

Connect the MAP sensor. DO NOT use the RED wire if TEEing into the factory MAP sensor wiring.

Connect the ORANGE wire to a switched 12V IGN source that is hot in Accessory, Start and Run

Connect the YELLOW wire to a clean (noise-free) 0-5V or 0-12V square wave RPM signal source. On some vehicles this signal is available from the engine computer (like certain Ford models or nearly all BMW models). On other vehicles this signal should be taken from the output of the CAMshaft position sensor only if the sensor is a 3-wire Hall-Effect type. CRANKshaft sensor should not be used and 2-wire (inductive) sensors cannot be used. On other vehicles the low-voltage 5V trigger signal between the engine computer and the coil-on-plug module on CYL 1 can be used or the connection between the engine computer and the CYL 1 injector, although these two options often result in noisy readings where the RPM signal is erratic. In some cases, the only way is a 3rd party CANBus to RPM converter like CANM8 (<http://www.canm8.com/can-bus-interfaces/rpm-pulse-interfaces/canm8-rpm.html>) – DO NOT USE any other module that receives data through the OBD-II port. RPM readings obtained through the OBD-II port are too slowly updated to be useful for real-time water methanol injection.

Connect the heavy gauge BLACK wire from the controller's BATTERY power harness to a clean vehicle chassis ground connection closes to the controller. Try to locate a factory ground point (usually a threaded stud) that is used for factory wire grounding in the vehicle.

Connect the heavy gauge RED wire to the car's +12V battery terminal through a 40A inline fuse installed RIGHT AT THE BATTERY. DO NOT INSTALL WITHOUT A FUSE.

Wiring Diagram

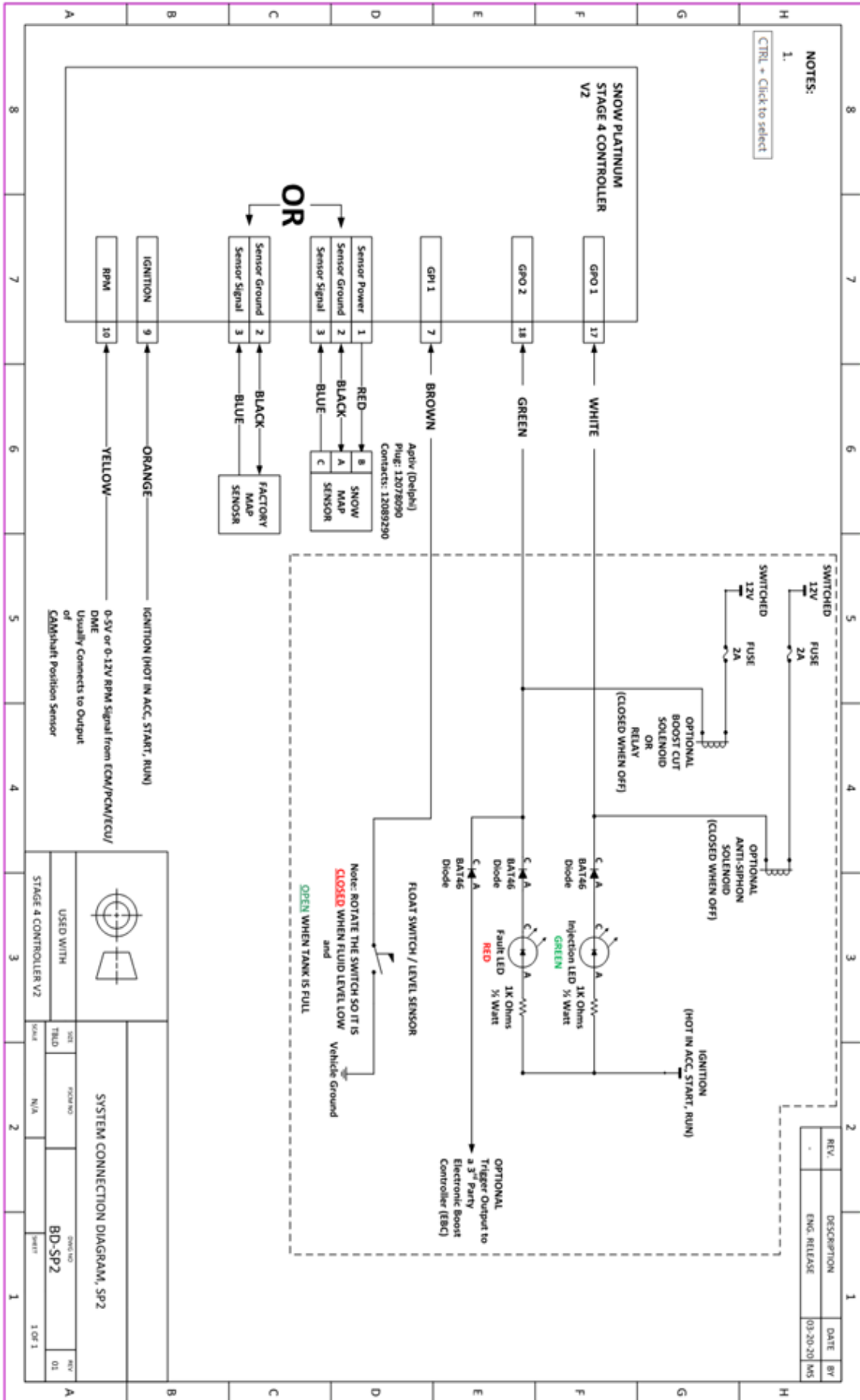

Step 7 Installing the Snow Platinum PC Software (Windows 10 ONLY)

Download, save, unzip and install the latest Snow Platinum Software from

<https://www.snowperformance.net/instructions.asp>

Launch the software.

Step 8 Connecting the Controller via USB

With the PC Software launched, connect the laptop to the controller using the provided USB cable.

Ensure the word “Connected” is displayed at the top and that the second LED from the top on the controller is illuminated. This indicates that Windows enumerated the controller’s USB connection. This may be instant on take a couple of minutes the first time.



Step 9 Wiring Checkout

At this point it’s useful to check that the wiring is all correct. PLEASE NOTE this will run the pump, so ensure the feed to the engine is disconnected and any fluid in the lines is drained into a bucket or a plastic bottle.

Turn the key so IGN is ON, but don’t start the engine

On the Settings tab

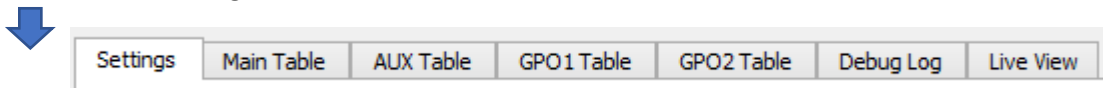

Scroll down to the Output Overrides section and click in the MAIN output pump field and type in 50 and click Set.

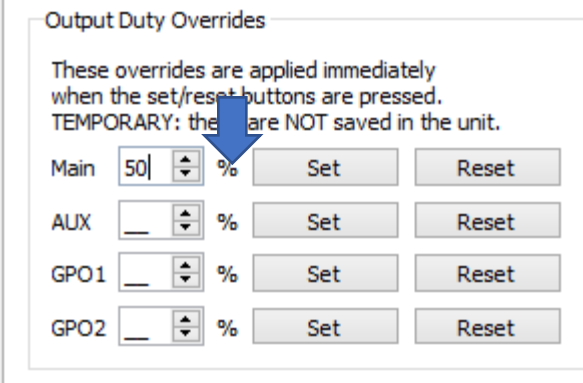

If all the wiring is OK you should hear the pump run. If it does, click Reset to stop it.

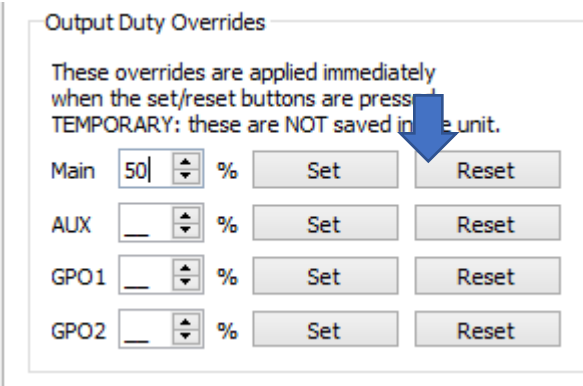

If you have a relay or solenoid or light (LED) connected to General Purpose Outputs 1 or 2 (GPO1 and GPO2) you can also test them this way, but ensure you are using 100% duty ONLY. With solenoids or relays you may need a helper to listen for the CLICK as you toggle Set and Reset.

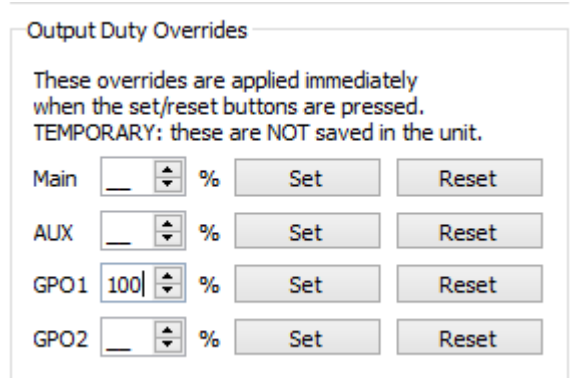

Step 10 Unit Calibration

Ensure Ignition is OFF

Unless already done, connect the controller and the laptop using the supplied USB cable (See Step 3)

Always, Always, Always, Always start by clicking the Read button from the top menu. This will ensure that the current calibration loaded in the controller is imported into the software.



Ensure you are on the Settings tab:

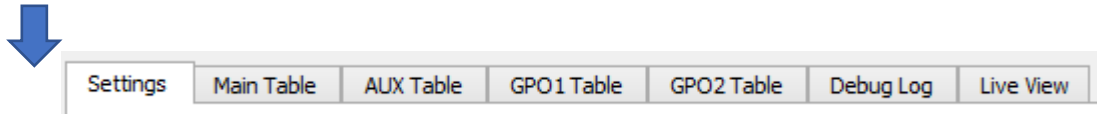

Always, Always, Always, Always ensure the MAP sensor values match the MAP sensor being used by the controller. Unit is pre-loaded from the factory with the values for the 100PSI MAP sensor. Once set these values **SHOULD NEVER** be changed. If these settings are wrong for the MAP sensor being used – the unit will not read correct boost and your Water Methanol Injection will not function properly (if at all)

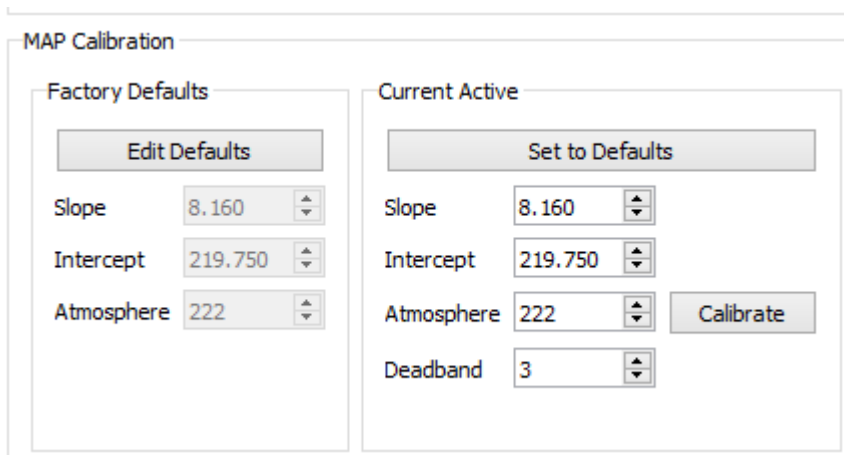

Next, focus on the Basic Config. These settings are VERY IMPORTANT because they set the controller limits of operation.

Enter the Max Engine Speed value that's 500-1000RPM higher than your REV limit

Max Engine Speed RPM

Enter the Minimum Boost value that you want to see in the pump duty table. This value should be a few PSI lower than the boost pressure at which you want to start injecting.

Min Boost PSI

Enter the Maximum Boost value that you want to see in the pump duty table. This value should be a few PSI higher than the maximum boost that can ever be developed in this setup.

Max Boost 36 PSI

Alternately, you can use the Settings Wizard

Basic Config

Max Engine Speed	8000	RPM
Pulses per Revolution	0.50	pulses/rev
Boost Units	PSI	
Open Settings Wizard ←		
Min Boost	0	PSI
Max Boost	30	PSI
Min Analog A Input	0.0	V
Max Analog A Input	5.0	V
Min Analog B Input	0.0	V
Max Analog B Input	5.0	V

Which will ask for a few simple parameters

Settings Wizard

Start Injection	3	PSI
<i>Point at which injection will begin.</i>	1500	RPM
Full Injection	29	PSI
<i>Point at which injection will be at maximum flow.</i>	4000	RPM

OK Cancel

and build a 2D linear map for the MAIN pump output

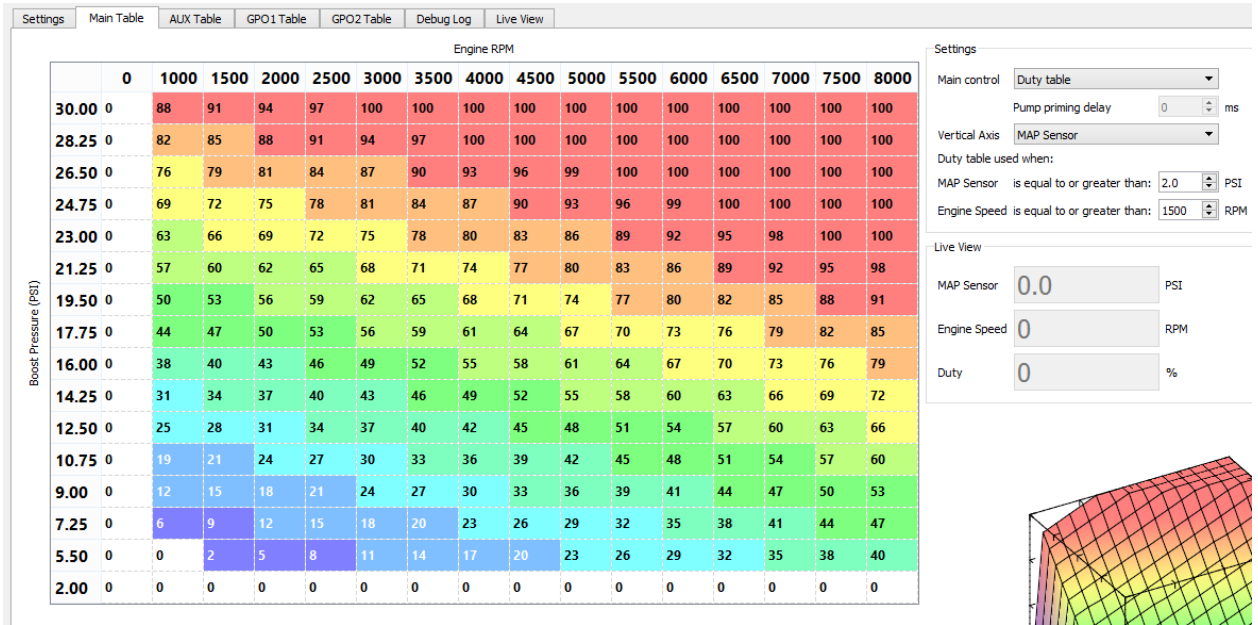

This map can (and should be) fine tuned on the dyno to achieve optimal injection performance for a given setup.

Just like the MAP sensor values, once set, the Basic Config **SHOULD NEVER** be changed.

Basic Config

Max Engine Speed RPM

Pulses per Revolution pulses/rev

Boost Units

Min Boost PSI

Max Boost PSI

Min Analog A Input V

Max Analog A Input V

Min Analog B Input V

Max Analog B Input V

Step 6 Ensuring the RPM Displays Correctly

RPM readings are calibrated using the Pulses per Revolution field on the Basic Config Section

Pulses per Revolution pulses/rev

For most setups the value that is used ranges from 0.5 to 3, depending on where the RPM signal is obtained from.

Enter an initial pulses/revolution value (start at 0.5) and click Write All (**Always use Write All**, not Write)



Next, start the car and Click Live Updates (and ensure the indicator to the left of it turns Green)

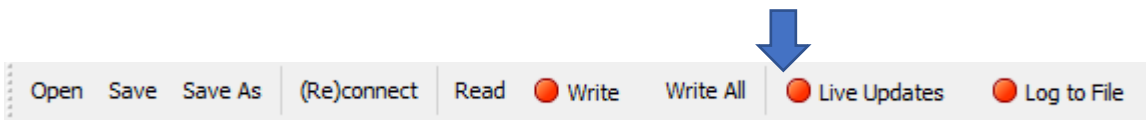

Next Click on the Live View Tab to view RPM readings reported by the controller

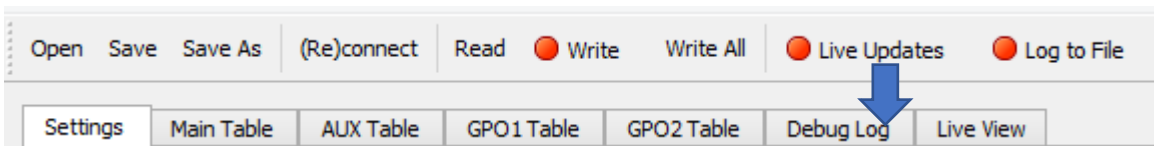

If the RPM reading on the Live View Tab doesn't match the reading on the dash, go back to the Basic Config Tab, adjust the value with the up/down arrows

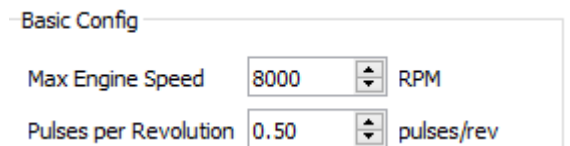

And click Write All to apply the new value to the unit. Check the Live View tab again and repeat until the readings match. Turn off the engine.

Step 7 Last Step

Click Read one more time to ensure the software imports the current controller parameters.

Click Save As and save this starting calibration file to your PC so you can go back to it.

General Notes

Always Click Read every time you connect the controller.

Use the SaveAs feature to save various calibrations under different names so you can go back to a previous calibration if the latest one doesn't work out.

Always apply changes to the unit with the Write All button – don't use the Write button



Tips

Finding a Boost reference: Boost pressure will be present anywhere after the compressor (turbo/supercharger). Many times a vacuum T can be used to tap into an existing vacuum/boost line, but on newer engines and some superchargers there may not be any lines to use. In this case a threaded hose barb or boost port will need to be screwed into the charge pipe or manifold to get a good boost reading. The Bosch map sensor included in this system is rated up to 40 PSI, damage to the sensor can occur if it is subjected to higher pressures.

Finding an RPM signal: For a vehicle with port injection or sequential fuel injection you may find a square wave signal by tapping into a fuel injector wire. For a direct injected engine the easiest way is to find the proper pin # on the OBDII port and tap into that.

Calibrating the RPM signal: The Stage 4 controller will read in pulses per revolution through the yellow wire. Under the SETTINGS tab, change the pulses to revolution to $\frac{1}{2}$ the number of cylinders.

Calibrating the MAP sensor: Select the MAP sensor calibration tab and enter the values from the sticker on the map sensor for Slope, Intercept and Atmosphere in the CURRENT ACTIVE box then hit calibrate. This will in essence zero the MAP sensor for your elevation. Make sure the engine is OFF during this adjustment.

Tuning Quick Reference

The power potential of the system is realized through increased boost and/or timing. The large gains on octane and cooling provided by the system make this possible, even on standard pump fuel.

The Boost Cooler® adds an alternate fuel source as well as significantly cools combustion. With the Boost Cooler®, one does not need to cool combustion with overly rich air/fuel ratios. To minimize combustion quench, you should start with an air to fuel ratio of 12.0-12.5:1. Injecting water/methanol lower than 3300-3500 RPM could result in combustion quench.

All vehicles are different. If the engine bogs or loses power, then injection is starting too early, the quantity is too much, or there is not enough methanol in the mixture (50/50 water/methanol recommended).

Maintenance/Longevity

Remove nozzle(s) and clean screen filters once per year using a calcium removing formula such as CLR®

The Boost Cooler® has been designed to operate with high concentrations of methanol. Oil or other additives are not required for system lubrication, and can cause damage to the system.

Contaminants in the fluid such as dirt can damage the system. Ensure that dirt and debris do not fall into the tank. This can lead to solenoid/pump failure.

Make your electrical connections tight: wire connection that is not visibly loose can still cause electrical faults. Wires run outside the vehicle must use heat shrink protectors or tightly wrapped electrical tape to protect the connections.

Do not use Teflon tape or paste to seal connections. These sealers are not as effective as the E-6000 sealant provided and can break down over time with high methanol use, clogging component.

Ensure the lines and wires are secured with zip ties and tape against movement and vibration, movement of lines and wires will cause wear which can lead to leaks and electrical faults.

Push connect lines must seat cleanly against the O-ring inside the push connect fitting: a line making a sharp bend from the fitting may lead to the line seating unevenly on the O-ring.

To cut the lines it is recommended a fresh razor blade is used and apply as little pressure as possible when cutting. Using wire snips or dull instruments can lead to burrs or ovaling which can score the O-ring when the line is inserted.

Pick the right pump for your application: if your pump will be mounted in the engine bay where it may be exposed to road spray or tire wash, Contact us at tech@snowperformance.net to see if an Extreme Environment pump is right for you.

Water-Meth FAQ

Q: How long will a 3 Qt tank of water/methanol last?

A: This depends on a number of variables (HP, injection system, settings, driving style, etc.) For most gasoline engines in the 250-550 HP range the standard 3Qt reservoir will last around two 12-15 gallon tanks of gasoline.

Q: What fluids can I use in my water/methanol system?

A: Boost Juice®: This is the best fluid to use and is Snow Performance's 49% methanol, 51% water mixture that can be shipped to your door or picked up at a local dealer. (If you are using your washer reservoir as the injection tank, Boost Juice® is a great washer fluid and can be injected directly on the windshield without damaging the vehicle.)

- Windshield Washer fluid: Only if it is blue in color and rated for -20 deg F. It should have no special additives. This means it is safe to use and made of 30% methanol, 70% water. If it is another color or another temperature rating, **do not use it**. You can "spike" your Blue -20 Washer fluid to a 50% mixture by adding 3 12OZ yellow bottles of Heet® gas-line-antifreeze to every gallon of washer fluid.
- Mix your own: You just need to make sure the methanol is "neat" and contains no lubricants or other additives. We recommend a 50% mixture by volume of M-1 pure grade methanol and distilled water.
- Do NOT use E85 or any other fluid with gasoline mixed in. It will destroy the fluid delivery part of your Boost Cooler® and instantly void the warranty.

Q: Do I have to have a custom dyno tune with a water-meth kit?

A: While extremely recommended for maximum performance and safety while injecting water-methanol a custom tune is not necessary to operate the vehicle as long as the following are met. 1) The vehicle is not utilizing a existing custom tune for the water-methanol 2) A low methanol concentration is being injected and not severely effecting the air/fuel ratio. Consult your local dyno professional for tune / recommendation.

Q: What ratio of water/methanol is recommended?

A: A 50/50 ratio is recommended for maximum performance and safety. Ratios of anywhere from 30% to 50% methanol work well and deliver excellent octane gains and cooling without over richening the air fuel ratio.

Q: Can I use pure methanol?

A: While all components of Snow Performance systems are designed to be able to handle 100% pure methanol, it is not recommended for a number of reasons.

- Safety: Pure methanol is easy to ignite with a low 140F degree flash-point and burns with an invisible flame.

- Performance: Water absorbs almost twice as much heat as methanol in the intake and inside the combustion chamber. Water cannot be flash-ignited, so has what is almost an infinite octane number. In the government studies for WWII piston-powered aircraft, 50/50 water-methanol was found to be the best fluid to use for auxiliary fluid injection.

Q: Can I inject water/methanol with nitrous?

A: Yes! With nitrous, water/methanol injection allows the use of more timing advance even with large (250HP+) quantities. The cooling effect of the water/methanol inside the combustion chamber also makes for reduced peak combustion temperatures.

Q: Should I mount my nozzles pre or post turbo/supercharger?

A: • Centrifugal Supercharger/Turbo: Never mount an injector nozzle before a centrifugal supercharger or turbocharger compressor. Sending fluid through the compressor wheel that spins anywhere from 50,000rpm to 250,000rpm can erode the leading edges of the fine aluminum. Studies performed by SAAB, concluded that pre-turbo injection will over time cause cavitation on the turbo wheel leading edges.

• Positive Displacement Supercharger: Mounting the nozzle before this style of blower is perfectly safe and actually provides some additional benefits. The small amount of water-methanol fluid isn't harmful to any rotor seals or surfaces or coatings. Additionally, it keeps the rotors and housing MUCH cooler, which reduces heat transfer to the rest of the intake and air charge.

Disclaimer

Do not use this product until you have carefully read the following agreement.

This sets forth the terms and conditions for the use of this product. The installation of this product indicates that the BUYER has read and understands this agreement and accepts its terms and conditions. Performance products by their nature are designed to increase horsepower and performance not engineered in the original vehicle and the increased stress could result in damage to related systems. This is a high performance product – use at your own risk. Snow Performance Inc., Its agents, employees or owners shall not be under any liability whether in contract or otherwise whether or not resulting from our negligence or contents of information supplied for any damage or loss resulting from such information. The BUYER is responsible to fully understand the capability and limitations of his/her vehicle according to manufacturer specifications and agrees to hold the SELLER harmless from any damage resulting from failure to adhere to such specifications. The SELLER disclaims any warranty and expressly disclaims any liability for personal injury or damages. The BUYER acknowledges and agrees that the disclaimer of any liability for personal injury is a material term for this agreement and the BUYER agrees to indemnify the SELLER and to hold the SELLER harmless from any claim related to the item of the equipment purchased. Under no circumstances will the SELLER be liable for any damages or expenses by reason of use or sale of any such equipment. The BUYER is responsible to obey all applicable federal, state, and local laws, statutes, and ordinances when operating his/her vehicle, and the BUYER agrees to hold SELLER harmless from any violation thereof. The SELLER assumes no liability regarding the improper installation or misapplication of its products. It is the installer's responsibility to check for proper installation and if in doubt, contact the manufacturer.

Notes: The contents of this document are subject to change without prior notice. No part of or this entire document may be reproduced in any form without prior written permission of Snow Performance, Inc. under the copyright except for private use.

Note that this information is subject to change. Please refer to www.snowperformance.net for current information.

Snow Performance 1-Year Warranty Policy:

Snow Performance, Inc. warrants that the Product shall conform to and perform in accordance with published technical specifications and shall be free of defects in materials and workmanship for 1-year providing:

1. You are the original purchaser and provide proof of purchase.
2. The system was purchased from a Snow Performance Authorized Dealer at MRP pricing set by SnowPerformance.*

***No warranty will be offered for any Snow Performance products if purchased below MRP. For MRP pricing of your product check www.snowperformance.net.**

3. An RMA # has been attained and is displayed on package containing returned part.
4. Parts Warranty ~ 90 day warranty on parts purchased separately if used in conjunction with a Snow System. No warranty implied if used with a non-Snow part/system. Subject to Snow's inspection of the product, Snow will remedy defects in materials and/or workmanship by repairing or replacing, at Snow's option, the defective product without charge for parts or labor, subject to the limitations and exclusions described in this warranty.

This warranty does not cover problems caused by normal wear and tear including aesthetic oxidation of surfaces, accidents, unlawful vehicle operation, or modifications or repairs to product not performed or authorized by Snow. This includes any product that is disassembled or taken apart for any reason.

In addition, this warranty does not cover problems resulting from conditions beyond Snow's control including, but not limited to, theft, misuse, overloading, or failure to assemble, mount or use the product in accordance with Snow's written instructions or guidelines included with the product or made available to the original retail purchaser. In the event of failure, Snow will repair or replace the part at Snow's sole discretion. Failures resulting from misapplication or misuse of the Product, failure to adhere to any specifications or instructions, or failure resulting from neglect, abuse, accidents, or act of nature are not covered under this warranty.

Warranty service may be obtained by emailing tech@snowperformance.net with a copy of your purchase invoice for the product, getting an RMA (Return Merchandise Authorization) number, and delivering the part to Snow. Customer agrees to insure the Product or assume the risk of loss or damage in transit, to prepay shipping charges to Snow, and to use the original shipping container or equivalent. Shipping for Warranty replacement parts shipped outside the continental US will be charged to customer.

Non-Warranty Repair/Retest

Products returned due to damage or misuse and Products retested with no problem found are subject to repair/retest charges. Product will be returned to customer at customer's expense. A credit card number must be provided in order to obtain an RMA (Return Merchandise Authorization) number prior to returning Product.

Distributor/Dealer Warranty:

All customers/dealers must deal directly with Snow Performance to receive warranty. No warranty will be issued through a distributor for any reason.

Return Policy:

All returns must be called in for RMA #. Snow Performance will not take used kits or parts for refund. If you are returning an unused kit there is a 15% restocking fee minus shipping/handling. All returns must be made within 30 days of purchase date. No exceptions.

LIMITATION OF LIABILITY: REPAIR OR REPLACEMENT OF A DEFECTIVE PRODUCT IS THE ORIGINAL RETAIL PURCHASER'S EXCLUSIVE REMEDY UNDER THIS WARRANTY. DAMAGE OR INJURY TO THE ORIGINAL RETAIL PURCHASER, TO HIS OR HER VEHICLE, CARGO, OR PROPERTY, AND/OR TO ANY OTHER PERSON OR PROPERTY IS NOT COVERED BY THIS WARRANTY. THIS WARRANTY IS EXPRESSLY MADE IN LIEU OF ANY AND ALL OTHER EXPRESS WARRANTIES, WHETHER ORAL OR WRITTEN. SNOW'S SOLE LIABILITY IS LIMITED TO THE REMEDY SET

FORTH ABOVE. IN NO EVENT WILL SNOW BE LIABLE FOR ANY DIRECT, INDIRECT, CONSEQUENTIAL, INCIDENTAL, SPECIAL, EXEMPLARY, OR PUNITIVE DAMAGES OR FOR ANY OTHER DAMAGES OF ANY KIND OR NATURE (INCLUDING, BUT NOT LIMITED TO, LOST PROFITS OR LOST SALES). SOME STATES DO NOT ALLOW THE EXCLUSION OR LIMITATION OF INCIDENTAL OR CONSEQUENTIAL DAMAGES, SO THE ABOVE LIMITATIONS MAY NOT APPLY TO YOU.